

# External display

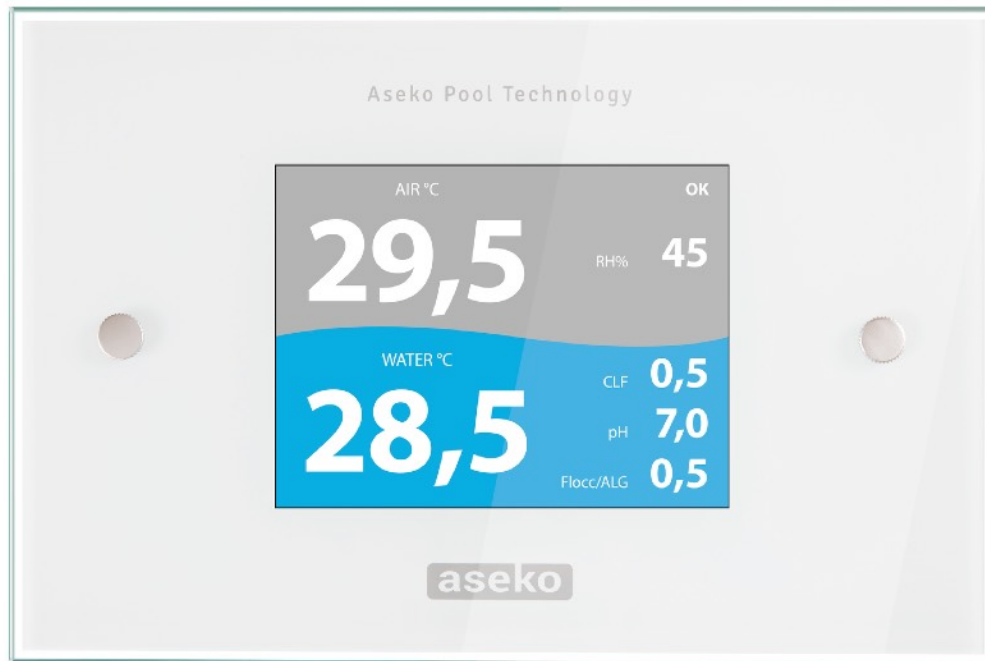

# General information

External display will allow you to monitor the pool condition in remote area, instead of directly on the ASIN Aqua. You can run filter backwash setup required values and state of the filtration. Display is made from stainless-steel and glass for the best impression of look and touch. It is possible to connect the display to all ASIN Aqua devices (except PROFi).

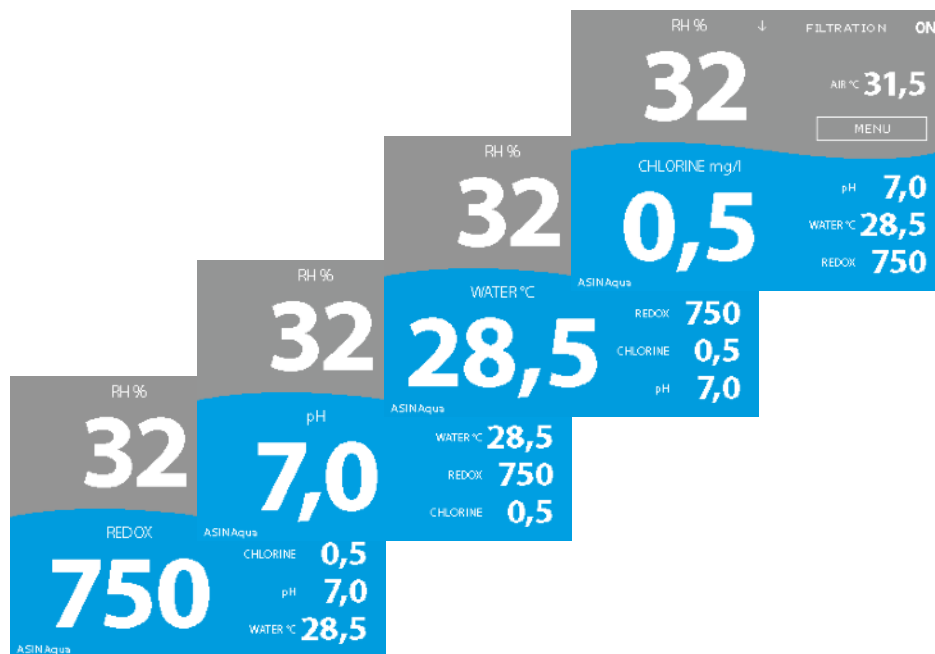

Lower part of the display can show informations about water temperature, pH, Redox or Chlorine

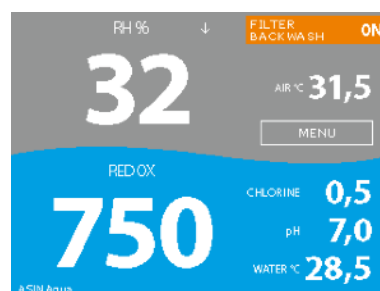
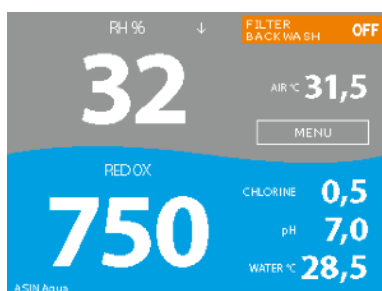

Filter backwash on/off



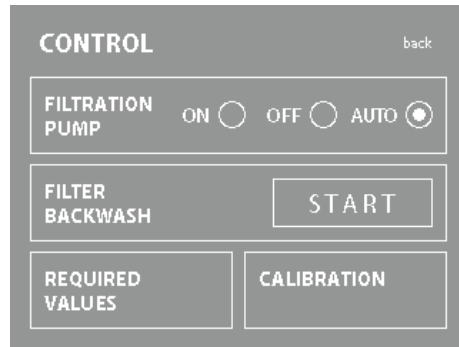
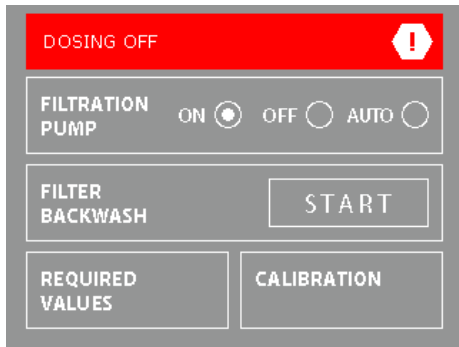

State of the filtration ON/OFF and Auto.  
 Once you turn OFF the filtration, the dosing will be switched off.

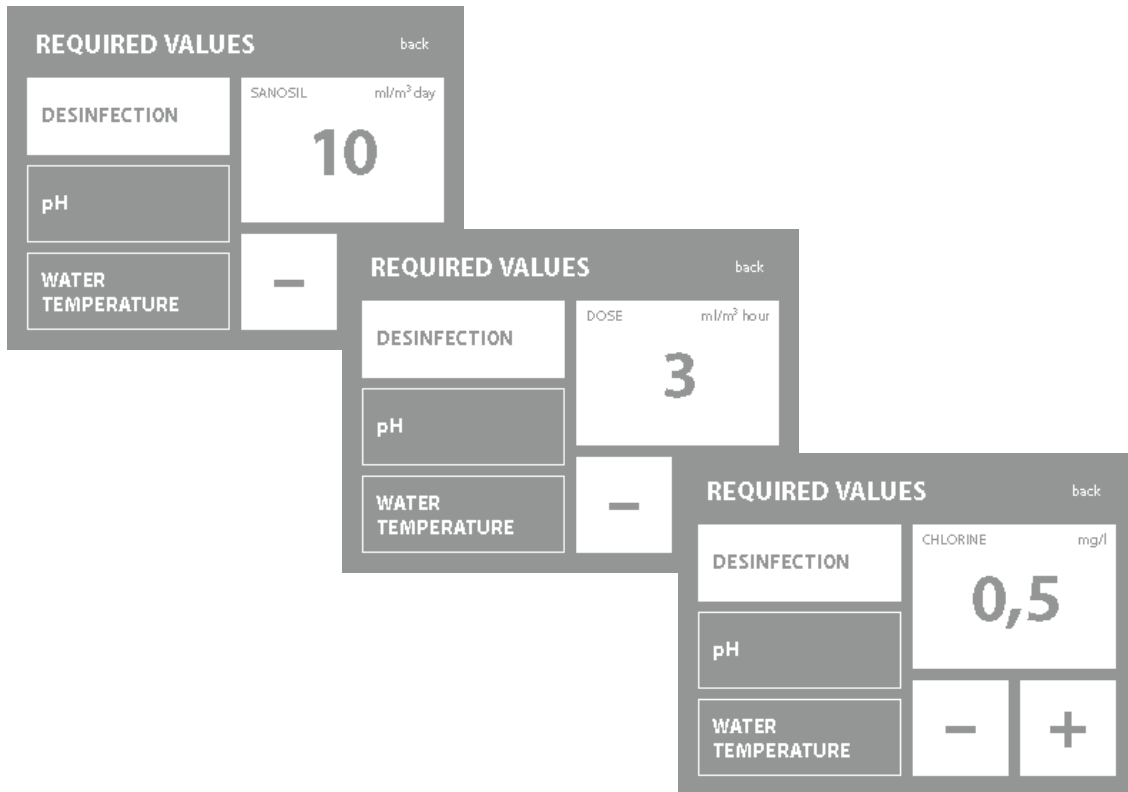

Setup of required values for SANOSIL, DOSE, CHLORINE, pH and water temperature



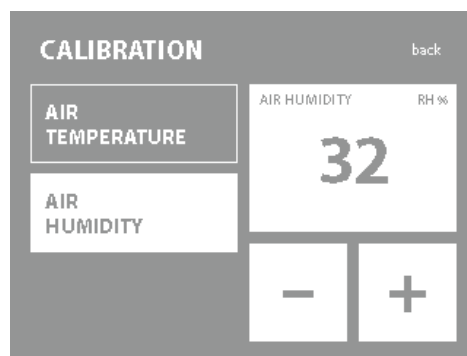
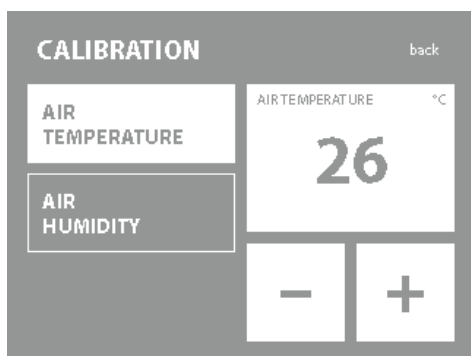

Calibration menu for air temperature and humidity

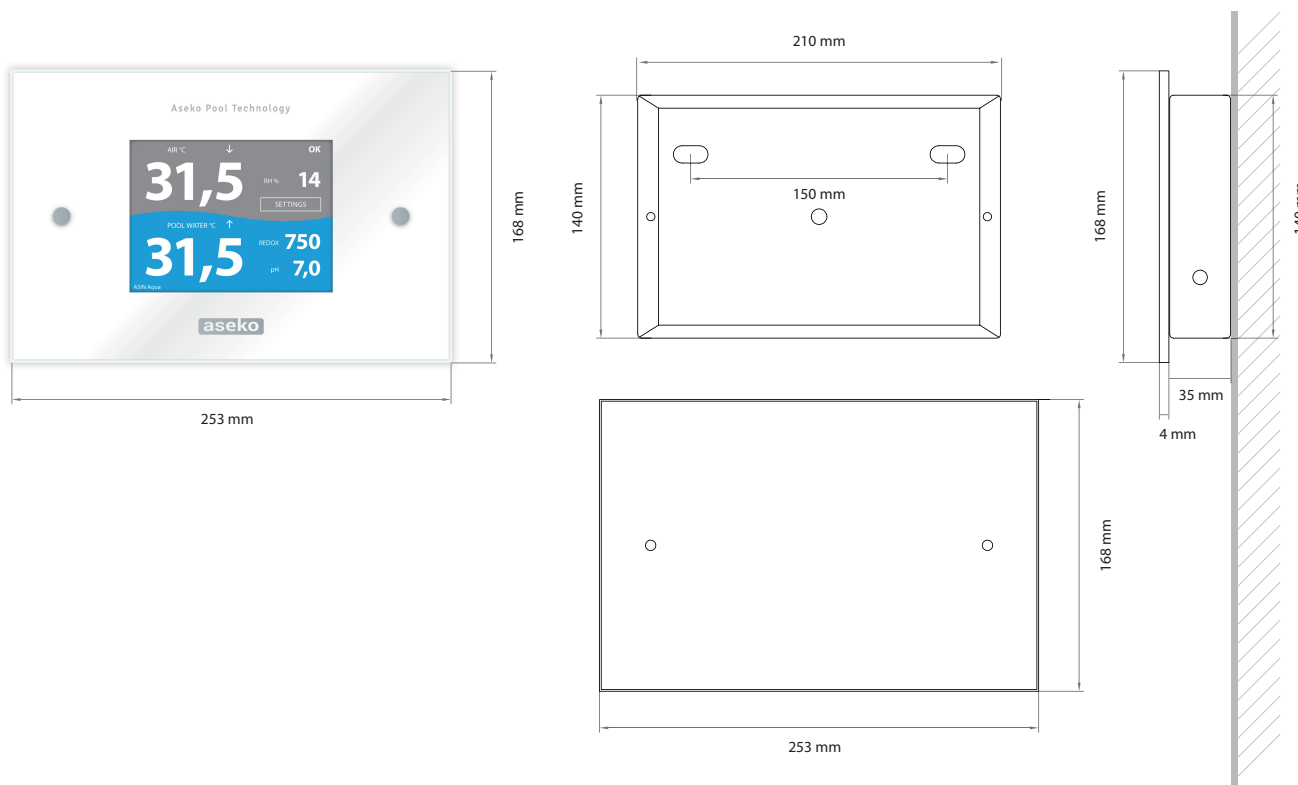

# Connection External display

ASIN AQUA Home, Oxygen, Salt

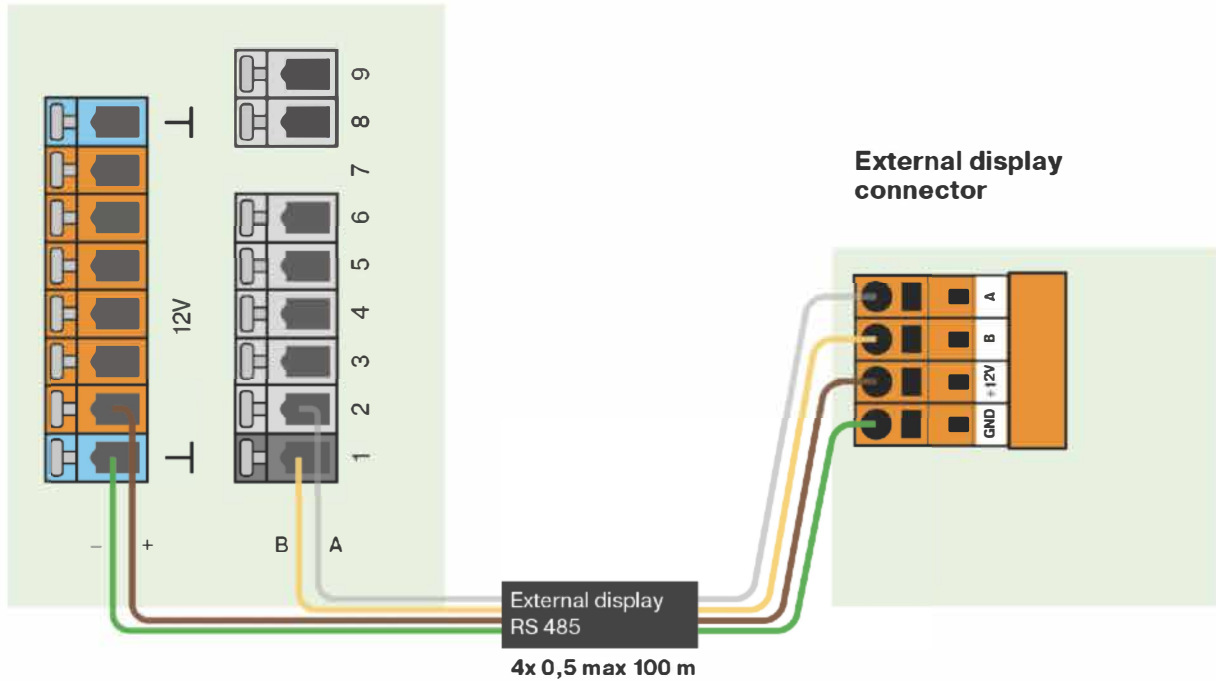

ASIN AQUA Net

